

Accuphase

INTEGRATED STEREO AMPLIFIER

E-280

- AAVA volume control
- Power amplification stage with bipolar transistors in double parallel push-pull configuration
- Rated for 120 watts into 4 ohms and 90 watts into 8 ohms
- High damping factor of 500
- Power amplification stage configured as instrumentation amplifier
- Current feedback amplification topology in power amplification stage
- Logic-control relays for shortest signal paths
- Strong power supply with massive high-efficiency transformer and large filtering capacitors
- Protection circuitry using MOS-FET switches
- Two rear panel expansion slots allow use of option boards





Integrated Amplifier with Scalability that Exceeds the Imagination

The AAVA volume control builds upon the knowledge of high-end equipment to control volume without loss of information. The power amplification section utilizes the instrumentation amplifier principle to create an ideal speaker driver. The low impedance design of the output circuitry brings out the full potential of every speaker. Two option boards can be added for improved expandability. The E-280 sound performance will defy the imagination.

Innovation – At the leading edge of technology

■ AAVA volume control

AAVA is a revolutionary type of volume control that completely does away with any variable resistors in the signal path, instead using a combination of 16 V-I converter circuits with different gain. Unlike conventional volume controls, the music signal is not attenuated by a rotary resistor, so that low distortion and an optimum S/N ratio can be maintained over the entire volume range. The E-280 utilizes maximum gain in 4 parallel rows and secondary V-I converter circuits arranged in 2 parallel rows, which doubles the total output current capability and halves the circuit impedance to further reduce noise.

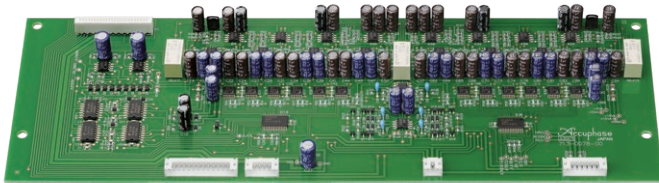

■ The noise-minimizing AAVA volume control assembly

[AAVA features]

- Purely analog principle avoids the inherent noise of digital circuitry
- Excellent S/N ratio at any volume level position
- No change in sound quality over the entire range
- Finely graded volume adjustment steps
- No volume difference between left and right channels
- High channel separation
- Left/right balance adjustment and attenuation also realized with AAVA

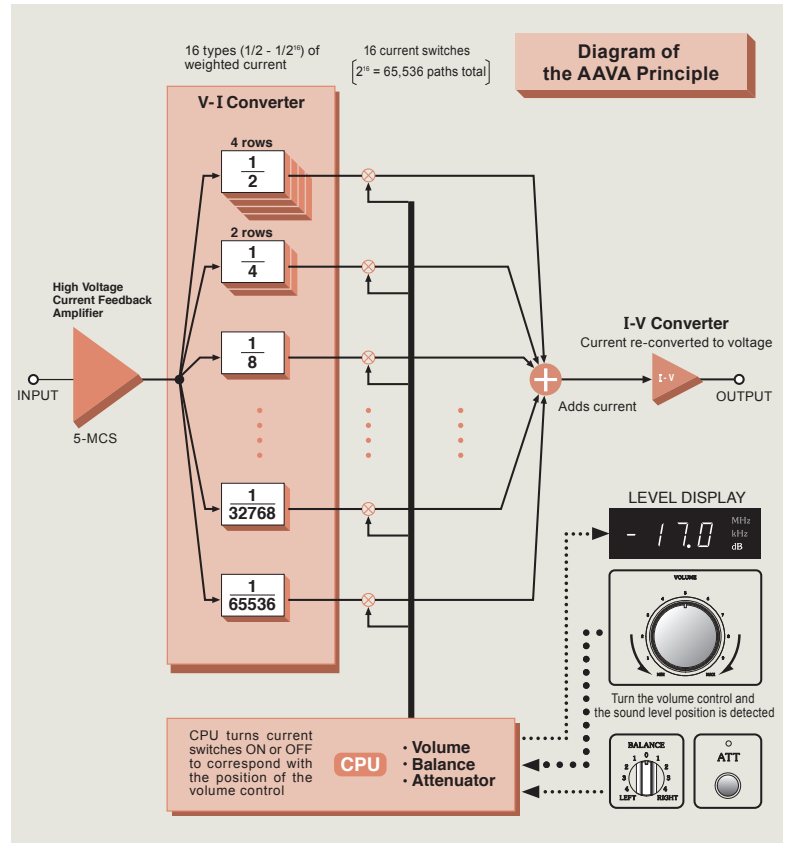

Sound quality – Simply aiming for the best

■ Reinforced power amplification stage

A power amplification stage with two bipolar transistors in a double parallel pull-push configuration for the left and right channels mounted directly to large heat sinks. Rated output of 90 W into 8 ohms or 120 W into 4 ohms of high power.

■ 25% improved damping factor

Balanced Remote Sensing and MOS-FET switches result in a damping factor of 500, representing a 25% improvement over the predecessor model.

■ Power supply circuitry designed for optimum stability

The large transformer and massive 30,000 μF filtering capacitors provide rock-stable high-quality power.



Massive transformer



Large filtering capacitors

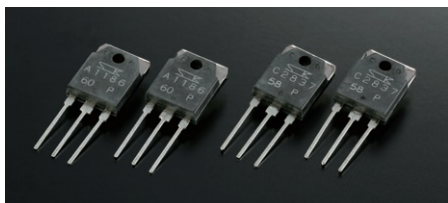

Bipolar power transistors

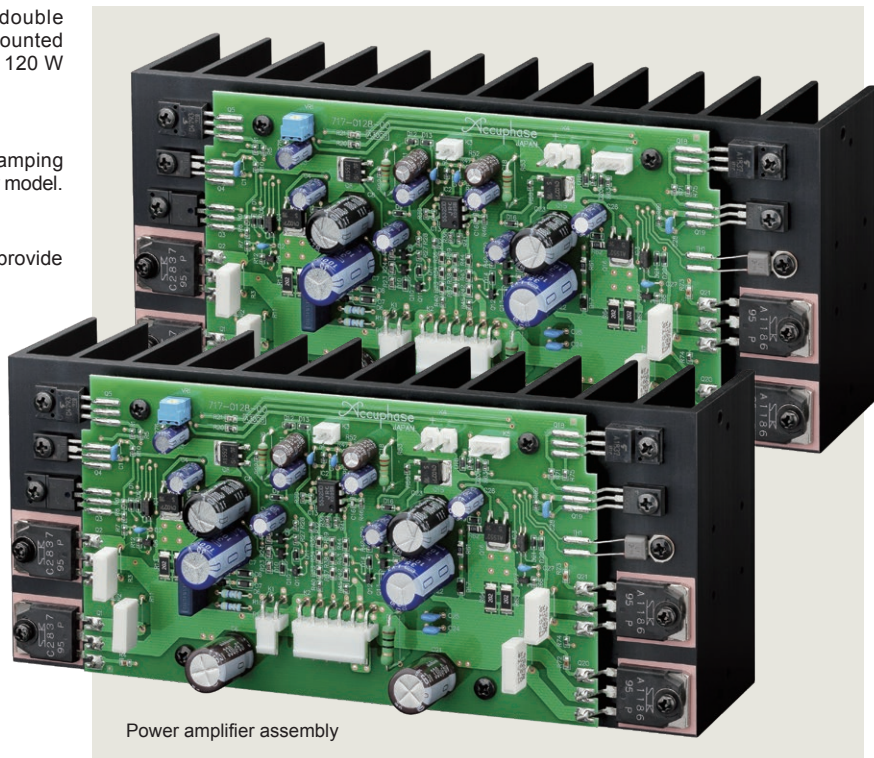

Power amplifier assembly

Advanced Functions



- | | | | | |
|---|--------------------------------|--------------------------------|--------------------|---|
| 1 Preamplifier / power amplifier separator switch | 3 Recorder selector | 6 MC / MM selector button | 9 Bass control | 12 Mono / stereo selector button |
| 2 Speaker output selector | 4 DAC input selector | 7 Phase selector button | 10 Treble control | 13 Loudness compensator on / off button |
| | 5 Display mode selector button | 8 Tone control on / off button | 11 Balance control | 14 Attenuator on / off button |

Advanced features

- Logic-control signal switching relays for shortest signal paths
- Five line level inputs and one balanced input
- Line input and output connectors for a recorder
- Individual phase setting for each input
- Stereo signal can be switched to monophonic operation
- Left/right balance control also realized with AAVA
- 20 dB attenuator
- Loudness compensator enhances low end presence
- Tone controls using summing active filters
- Power amplification stage configured as an instrumentation amplifier
- Current feedback amplification circuit topology assures excellent phase characteristics in high range
- Speaker output protection circuit guards against short-circuiting
- Protection circuitry using MOS-FET switches
- Two sets of large speaker terminals
- Preamplifier and power amplifier sections can be used separately
- Preamplifier outputs also support bi-amping connection
- Power amplifier inputs allow use of that section only
- Dedicated headphone amplifier designed for optimum sound quality
- Two rear panel expansion slots allow use of option boards
- DAC input selector button for use when digital input board (DAC-50 or DAC-40) is installed
- Numeric indication of digital signal sampling frequency (when DAC-50 or DAC-40 is installed)
- High-sensitivity analog peak power meters

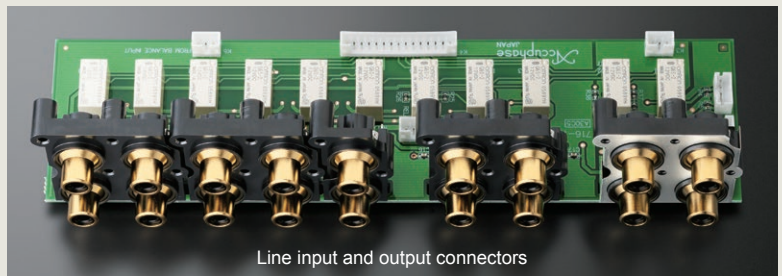

Line input and output connectors

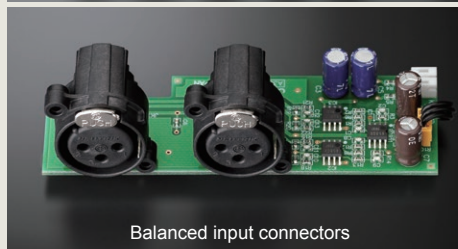

Balanced input connectors



Protection circuitry assembly

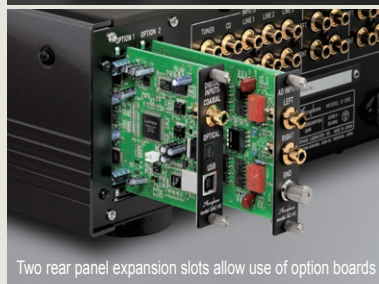

Two rear panel expansion slots allow use of option boards



Speaker terminals with thick, short connecting shafts



- Supplied Remote Commander RC-250 Allows volume adjustment, input source switching, etc.



Bi-amping for further enhanced sound

In a bi-amped setup, the speaker units for the LOW frequency range and the HIGH frequency range are driven by separate amplifiers with equal gain, which enables playback with even higher sound quality.

* The speakers must have a built-in crossover network and separate inputs for the LOW and HIGH range.

* The example shows a setup with an additional power amplifier for the LOW frequency range.

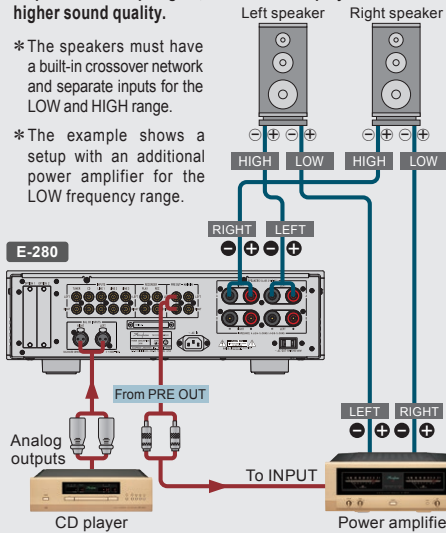

Option Boards



Photo shows an option board installation example.

Rear panel expansion slots allow use of three types of option boards (DAC-50, AD-50, LINE-10). Up to two boards can be installed, according to the requirements.

■ The following option boards can also be used:

Digital Input Board	DAC-40/DAC-30/ DAC-20/DAC-10
Analog Disc Input Board	AD-30/AD-20/ AD-10/AD-9
Line Input Board	LINE-9

Analog Disc Input Board AD-50

Features a high-performance phono equalizer for playback of analog records.

- Supports MC and MM cartridges
- Load impedance selector button (MC only)
- Subsonic filter

Cartridge	MC	MM
Gain	66 dB	40 dB
Input Impedance	30 ohms 100 ohms 300 ohms	47 kilohms

AD-50

Digital Input Board DAC-50

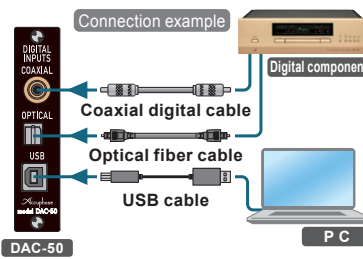

High-performance DAC with two AK4490EQ chips from Asahi Kasei Microdevices driven in parallel.

Input	Signal	Sampling frequencies	Number of bits
USB	DSD	2.8 MHz	1-bit
		5.6 MHz	
		11.2 MHz [11.2 MHz:] [ASIO only]	
PCM	32 to 384 kHz	32-bit	
OPTICAL	PCM	32 to 96 kHz	24-bit
COAXIAL	PCM	32 to 192 kHz	24-bit

Line Input Board LINE-10

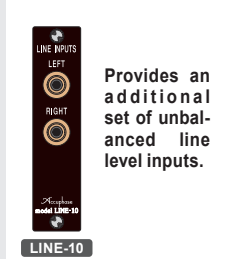

Provides an additional set of unbalanced line level inputs.

LINE-10

Front Panel

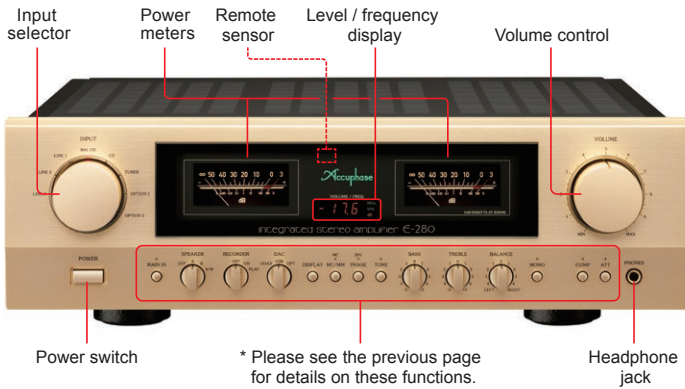

Rear Panel

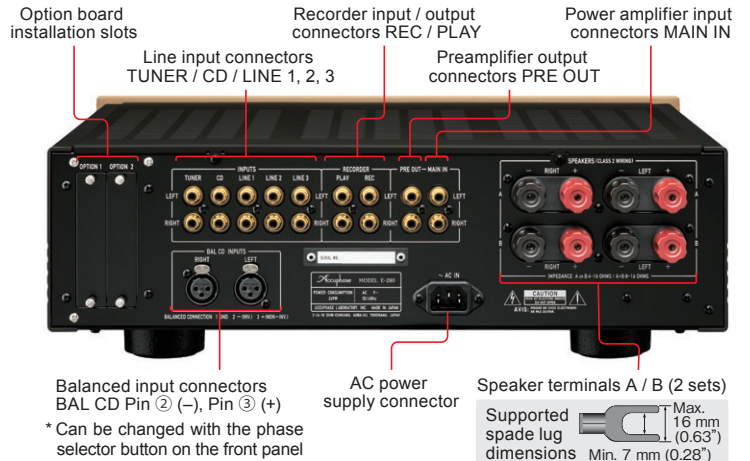

E-280 Guaranteed Specifications [Guaranteed specifications are measured according to EIA standard RS-490]

Continuous Average Output Power (20 – 20,000 Hz)	(both channels driven)	4-ohm load	120 W	
		8-ohm load	90 W	
THD (20 – 20,000 Hz)	(both channels driven)	4 to 16 ohm load	0.05%	
Intermodulation Distortion	0.01%			
Frequency Response	BALANCED INPUT	At rated continuous average output	20 – 20,000 Hz (+0, -0.5 dB)	
	LINE INPUT	At rated continuous average output	20 – 20,000 Hz (+0, -0.5 dB)	
	MAIN IN	At rated continuous average output	20 – 20,000 Hz (+0, -0.2 dB)	
		At 1 watt output:	3 – 150,000 Hz (+0, -3.0 dB)	
Damping Factor	500 (with 8-ohm load, 50 Hz)			
Input Sensitivity, Input Impedance	Input	Input sensitivity		
		For rated output	For 1 W output (EIA)	
	BALANCED INPUT	134 mV	14.2 mV	40 kilohms
	LINE INPUT	134 mV	14.2 mV	20 kilohms
Max. input voltage	BALANCED INPUT	5.0 V		
	LINE INPUT	5.0 V		
Output Voltage	PRE OUTPUT	At rated continuous average output	1.07 V	
Output Impedance	PRE OUTPUT	50 ohms		
Gain	BALANCED INPUT → PRE OUTPUT		18 dB	
	LINE INPUT → PRE OUTPUT		18 dB	
	MAIN IN → OUTPUT		28 dB	

Tone Controls	Turnover frequency and adjustment range	Bass: 300 Hz	±10 dB
		Treble: 3 kHz	±10 dB
Loudness Compensator	+6 dB (100 Hz)		
Attenuator	-20 dB		
S/N Ratio	Input	Input shorted (A weighting)	S/N ratio (EIA)
		S/N ratio at rated output	
	BALANCED INPUT	96 dB	97 dB
	LINE INPUT	107 dB	98 dB
MAIN IN	122 dB	102 dB	
Power meters	Logarithmic type peak level display of output in dB or percent		
Output Load Impedance	1 set of speakers		4 to 16 ohms
	2 sets of speakers		8 to 16 ohms
Stereo Headphones	Suitable impedance		8 ohms or higher
Power Requirements	120 V, 220 V, 230 V AC (voltage as indicated on rear panel), 50/60 Hz		
Power Consumption	Idle		52 W
	In accordance with IEC 60065		249 W
Maximum Dimensions	Width 465 mm (18.31") × Height 151 mm (5.94") × Depth 420 mm (16.54")		
Mass	Net		20.4 kg (45.0 lbs)
	In shipping carton		26 kg (57 lbs)

Remarks

- ★ This product is available in versions for 120/220/230 V AC. Make sure that the voltage shown on the rear panel matches the AC line voltage in your area.
- ★ The 230 V version has an Eco Mode that switches power off after 120 minutes of inactivity.
- ★ The shape of the plug of the supplied AC power cord depends on the voltage rating and destination country.

Supplied accessories
● AC power cord
● Remote Commander RC-250

