

Accuphase

MDS COMPACT DISC PLAYER

DP-450

- High-grade CD drive
- MDS+ type D/A converter with four parallel circuits
- Direct Balanced Filter with separate line and balanced signal paths
- Programmable playlists that can change track order
- Sampling frequency and quantization bit display
- Transport outputs and digital inputs
- Digital interface with USB input
- Digital connection with an Accuphase voicing equalizer
- Balanced output phase selection



COMPACT
disc
DIGITAL AUDIO



The ideal CD player for disc playback

Accuphase has spent 35 years developing CD players in pursuit of the best in disc playback. The DP-450 CD player combines a number of innovative technologies, including a CD drive mechanism with a strong integrated structure, high-quality elastic dampers that protect the lens actuator from vibration, and MDS+ type D/A converters with four parallel circuits. The DP-450 extracts the full potential of any CD to deliver a listening experience that stays with you.

The Technology of Precision

Features and Functions of Transport Section

■ Accurate Reading

Vibration countermeasures in CD players that read audio data from rotating discs greatly impact the sound quality. By placing the high-rigidity drive mechanism as close to the base as possible, the DP-450 significantly reduces external vibrations from being transmitted to the traverse mechanism and protects the lens actuator that reads the discs. The high-quality elastic dampers that connect the traverse and disc loading mechanisms reduce the magnification of natural resonances in the lens actuator, improving reading precision. Additionally, the chucking magnet is an 8-pole neodymium bonded magnet for high magnetic flux density and dimensional accuracy. This chucking magnet secures the turntable and disc evenly and firmly to enable uniform disc rotation without wobbling.

■ Quiet Operation

Creating a quiet listening environment is a vital component in enjoying music. Vibrations from spinning discs that are transmitted to the chassis resonate and amplify operational sounds. The elastic dampers that support the traverse mechanism inhibit vibrations from discs and greatly reduce chassis resonance. The three-layer large bridge surrounding the traverse mechanism also shields against vibrational noise from high-speed rotation. This technological development allows the DP-450 to operate quietly without being affected by disc rotation.

■ Smooth loading

Carved from an aluminum block and then finished with a hard anodized aluminum and satin treatment, the elegant and elaborate disc tray uses high-quality bearing shafts to open and close smoothly and quietly.

■ High-grade CD drive

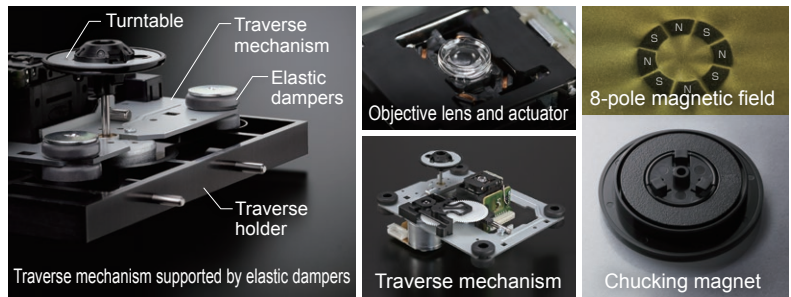
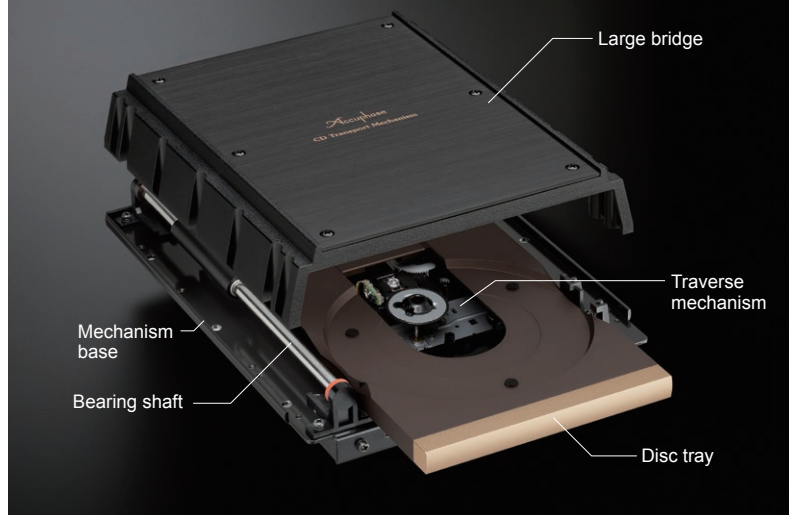

Features and Functions of the Digital Processor Section

■ MDS+ (Multiple Delta Sigma) type D/A converter with four parallel circuits

The MDS+ conversion principle is a revolutionary D/A conversion routing method that employs multiple delta-sigma type D/A converters connected in parallel for drastically improved performance. By passing output from the high-performance ES9026PRO DAC chip (ESS Technologies) through 4 parallel converter circuits, the DP-450 almost doubles ($\approx\sqrt{4}$) overall performance for distortion, noise, linearity, and more. Because the improvements provided by the MDS+ principle are independent of signal frequency and level, output signal noise at very low levels can also be minimized, a feat that conventional delta-sigma converters find extremely difficult to achieve.



DAC: ES9026PRO

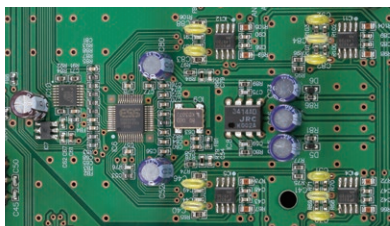

4MDS+ principle D/A converter

■ Direct Balanced Filter circuits

The Direct Balanced Filter circuits with independent line and balanced outputs achieve stable signal transmission because there is no interference from mutual loads, producing ideal performance and sound quality.

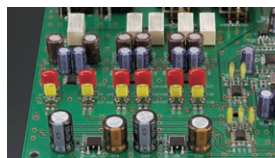

Direct Balanced Filter circuits

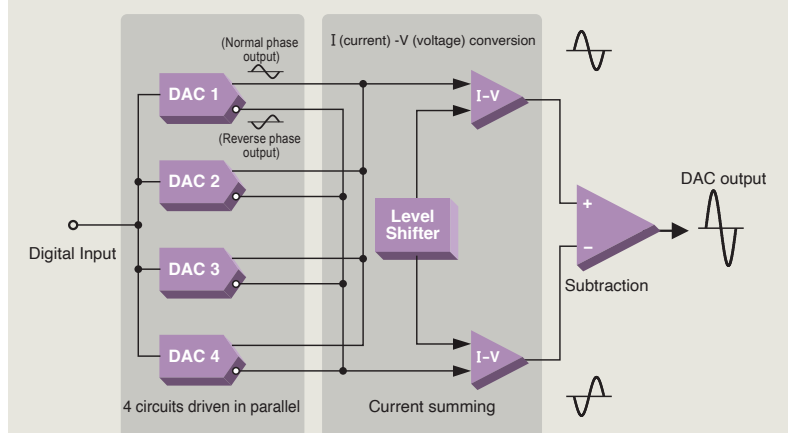

■ 4MDS+ type D/A converter block diagram

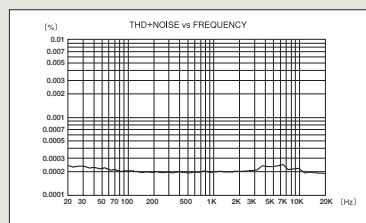

Total harmonic distortion (incl. noise) vs. frequency response

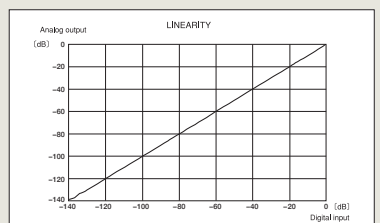

Linearity (digital input vs. analog output)

Advanced features

- A high-rigidity, top-quality CD drive that operates quietly
- MDS+ type D/A converter with four parallel circuits
- Direct Balance Filter circuits comprised of independent line and balanced circuits create the ideal signal output
- Power transformer with independent analog and digital windings
- Low noise power supply circuits using amplifier technology
- Programmable playlists so that you can enjoy your music in the order you want
- Display with sampling frequency and number of quantization bits
- Adjustable output level to match signal with different output levels from other players
- Digital connection to connect with an Accuphase voicing equalizer for sound field correction in the digital domain
- Digital inputs (USB, OPTICAL, COAXIAL) so you can enjoy a variety of sound sources
- Transport output terminals (OPTICAL, COAXIAL) that work with the D/A converter
- 2 (balanced, line) analog outputs
- Phase selector that can invert the balanced output
- Low-center of gravity thanks to a recessed bottom plate slot allowing the CD drive to be installed as low as possible
- Three-layer large bridge for excellent sound insulation
- High-quality, high-carbon cast iron insulators with exceptional vibration damping
- "Power-on play" that automatically starts playback with a timer (commercially available)



Digital inputs

Transport outputs

Balanced and line analog outputs

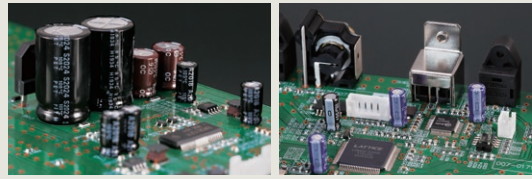

Low noise power supply circuits

Digital input & output circuits



DSD



PCM

Sampling frequency and quantization bit display

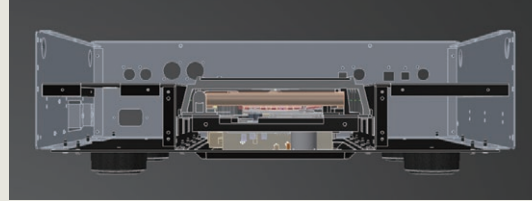

Low center of gravity with recessed CD drive placement

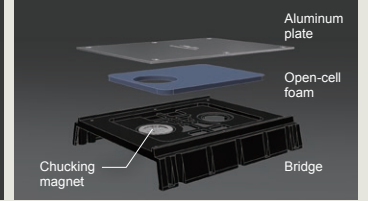

Three-layer large bridge with excellent sound insulation

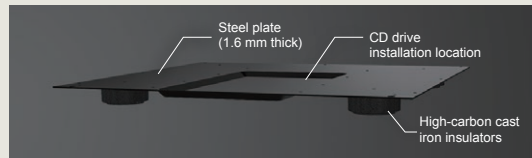

Bottom plate with recessed CD drive slot for ultimate low center of gravity



High-carbon cast iron insulators



Standard :

Minimum

Output level display



Programmable playlist

Phase selector

- Supplied RC-140 remote commander



Connecting to a voicing equalizer

By connecting a voicing equalizer between the transport outputs and digital inputs of the DP-450, sound field compensation in the digital domain becomes possible.

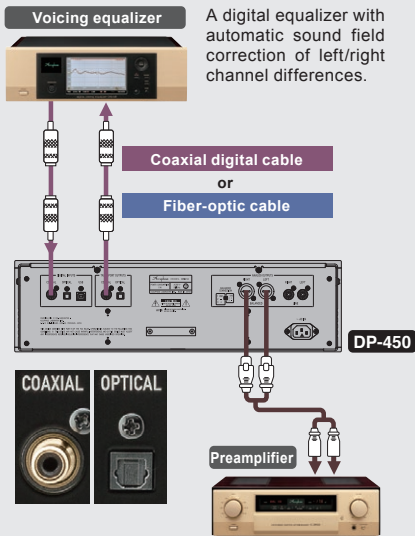

Connecting to a TV, etc.

Connecting the device to a TV, etc. using a digital signal allows the DP-450's high-grade D/A converter to convert analog sound and music signals for reproduction through your stereo system.

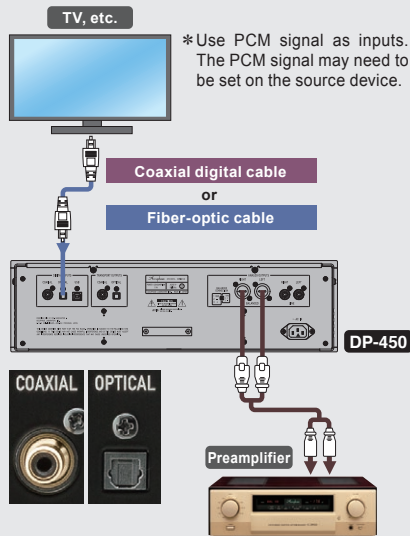

Connecting to computers, etc.

The DP-450 is equipped with a USB port (type B), allowing for high resolution playback when connected to a PC via a USB cable.

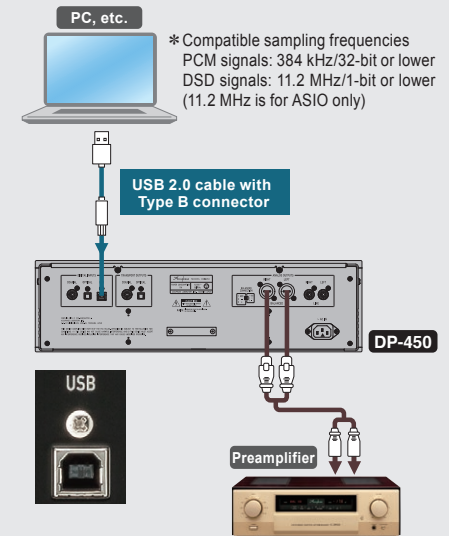

Front Panel

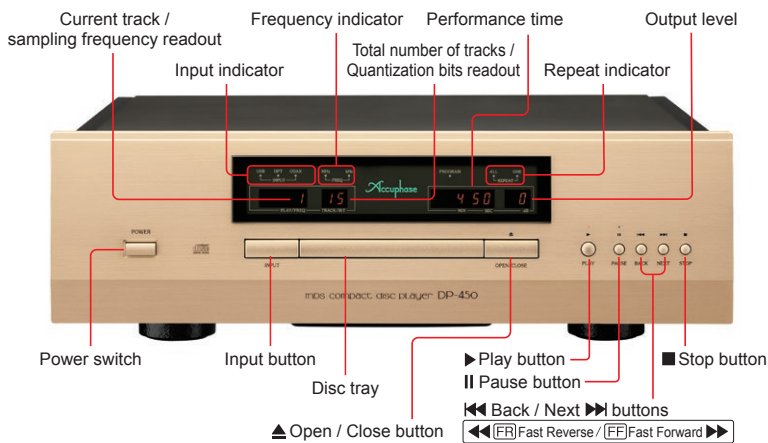

Rear Panel

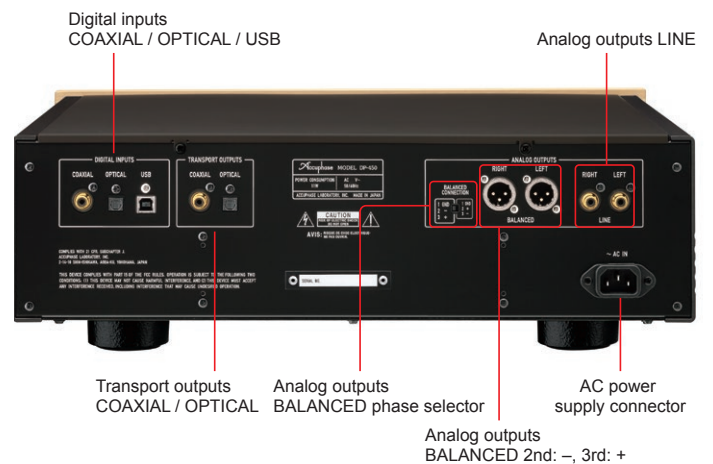

DP-450 Guaranteed Specifications [Guaranteed specifications measured according to the JEITA standard CP-2402A]

Compatible Disc Formats	CD		
Data Read Principle	Non-contact optical pickup		
Laser Diode Wavelength	790 nm		
Transport Outputs	OPTICAL	JEITA CP-1212 compliant	JEITA standard optical fiber cable
	COAXIAL	IEC 60958 compliant	75-ohm coaxial digital cable
Digital Inputs	USB	USB 2.0 Hi-Speed (480 Mbps) compliant	USB 2.0 cable with Type B connector
	OPTICAL	JEITA CP-1212 compliant	JEITA standard optical fiber cable
	COAXIAL	IEC 60958 compliant	75-ohm coaxial digital cable
Sampling Frequencies	USB	DSD	2.8 / 5.6 / 11.2 MHz (11.2 MHz is ASIO only)
		PCM	32 / 44.1 / 48 / 88.2 / 96 / 176.4 / 192 / 352.8 / 384 kHz
	OPTICAL	PCM	32 / 44.1 / 48 / 88.2 / 96 kHz
		COAXIAL	PCM

D/A Converter	4MDS+ principle	
Frequency Response	0.7 to 50,000 Hz	+0, -3.0 dB
THD + Noise	0.0008%	20 to 20,000 Hz
S/N Ratio	119 dB	
Dynamic Range	116 dB	
Channel Separation	113 dB	20 to 20,000 Hz
Output Voltage and Impedance	BALANCED	2.5 V 50 ohms
	LINE	2.5 V 50 ohms
Output Level Control	0 dB to -60 dB	In 1-dB steps Digital
Power Requirements	120 V, 220 V, 230 V AC (voltage as indicated on rear panel), 50/60 Hz	
Power Consumption	11 W	
Maximum Dimensions	Width 465 mm (18.3") × Height 151 mm (6.0") × Depth 393 mm (15.5")	
Mass	Net	13.7 kg (30.2 lbs)
	In shipping carton	20 kg (44 lbs)

Supplied accessories

- AC power cord
- USB Utility 3 CD
- Audio cable with plugs AL-10
- USB Utility 3 Setup Guide
- Remote Commander RC-140

Remarks

- ★ This product is available in versions for 120/220/230 V AC. Make sure that the voltage shown on the rear panel matches the AC line voltage in your area.
- ★ The 230 V version has an Eco Mode that switches power off after 120 minutes of inactivity.
- ★ The shape of the plug of the supplied AC power cord depends on the voltage rating and destination country.



ACCUPHASE LABORATORY, INC.

F2105Y 850-2224-00(B1) PRINTED IN JAPAN