

Accuphase

INTEGRATED STEREO AMPLIFIER

E-380

- AAVA volume control
- Power amplification stage with bipolar transistors in double parallel push-pull configuration
- Rated for 180 watts into 4 ohms and 120 watts into 8 ohms
- High damping factor of 500
- Power amplification stage configured as instrumentation amplifier
- Current feedback amplification topology in power amplification stage
- Logic-control relays for shortest signal paths
- Strong power supply with massive high-efficiency transformer and large filtering capacitors
- Protection circuitry using MOS-FET switches





Integrated Amplifier With More Output Power and Further Evolved Performance

The E-380 realizes a 20% increase in rated output power thanks to a reinforced power amplification stage and power supply. The further evolved AAVA volume control system allows music enjoyment at any level without even the slightest degradation of signal quality. The power amplifier section utilizes the instrumentation amplifier principle to achieve outstanding S/N ratio. Low impedance design of the output circuitry results in a damping factor of 500, ensuring that the potential of every speaker can be brought out to the fullest. Enjoy a musical performance of amazing transparency and dynamism.

Innovation - At the leading edge of technology

■ AAVA volume control

AAVA is a revolutionary type of volume control that completely does away with any variable resistors in the signal path, using instead a combination of 16 V-I converter amplifiers with different gain. Unlike in conventional volume controls, the music signal is not being attenuated by a rotary resistor, so that optimum S/N ratio and low distortion can be maintained over the entire volume range. The signal degradation and impedance changes of older designs are now a thing of the past. The E-380 uses four maximum-gain V-I converter amplifiers, followed by two amplifier circuits in parallel configuration, which doubles the total output current capability and halves the circuit impedance to further reduce noise.

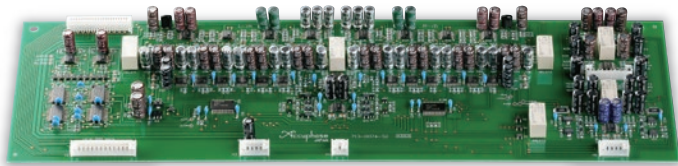

■ AAVA volume control assembly that minimizes noise

[AAVA features]

- Purely analog principle avoids the inherent noise of digital circuitry
- Excellent S/N ratio at any volume level position
- No change in sound quality over the entire range
- Finely graded volume adjustment steps
- No volume differences between left and right channel
- High channel separation
- Left/right balance adjustment and attenuation also realized with AAVA

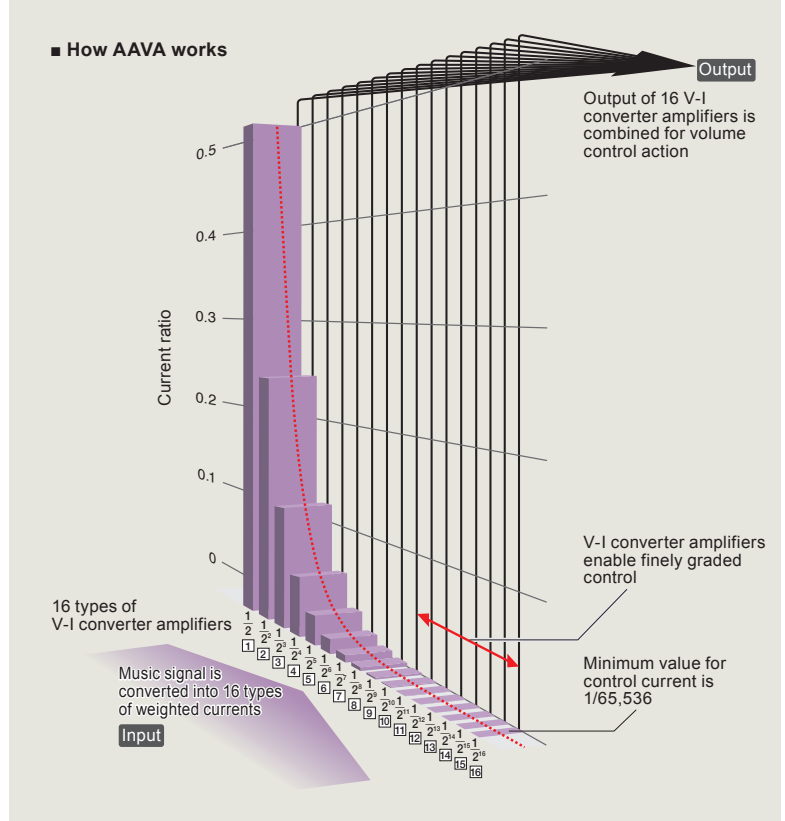

Sound quality - Simply aiming for the best

■ Power amplification stage with bipolar transistors

The power amplification stage features bipolar transistors in a double parallel push-pull configuration.

■ 25% improved damping factor

Balanced Remote Sensing and MOS-FET switches result in a damping factor of 500, representing a 25% improvement over the predecessor model.

■ Power supply circuitry designed for optimum stability

The large transformer and massive 33,000 μF filtering capacitors with 10% more capacitance provide rock-stable high-quality power.

■ 20% more rated output power

Two power amplifier units for left and right mounted directly to large heat sinks deliver ample power, rated for 120 watts into 8 ohms or 180 watts into 4 ohms.



Massive transformer



Large filtering capacitors

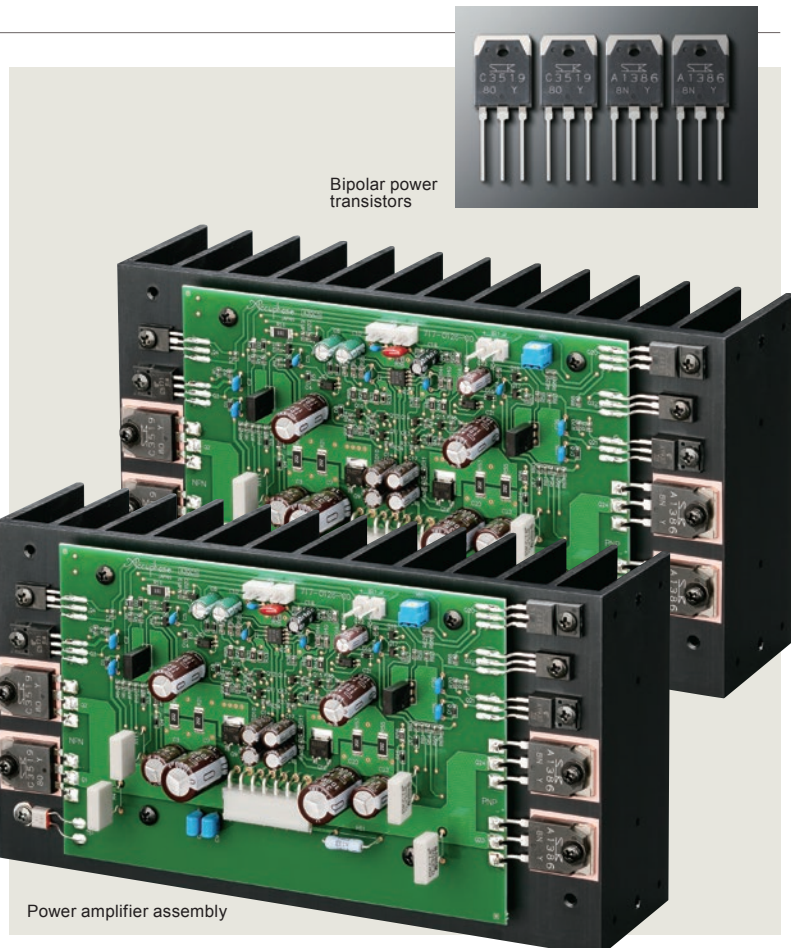
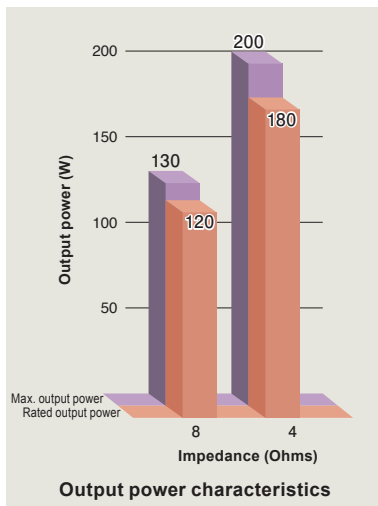

Advanced features

- Logic-control signal switching relays for shortest signal paths
- Five line level and two balanced inputs
- Line input and output connectors for a recorder
- Individual phase setting for each input
- Stereo signal can be switched to monophonic operation
- Left/right balance control also realized with AAVA
- Convenient attenuator is useful for example when operating an analog record player
- Loudness compensator enhances low end presence
- Tone controls using summing active filters
- Power amplification stage employs instrumentation amplifier principle
- Current feedback amplification circuit topology assures excellent phase characteristics in high range
- Speaker output protection circuit guards against short-circuiting
- Protection circuitry using MOS-FET switches
- Two sets of large speaker terminals
- Preamp and power amp sections can be used separately
- Preamp outputs also support bi-amping connection
- Power amp inputs allow use of that section only
- Dedicated headphone amplifier designed for optimum sound quality
- Two rear panel expansion slots allow use of option boards
- DAC input selector button for use when digital input board (DAC-40 or DAC-50) is installed
- Numeric indication of digital signal sampling frequency (when DAC-40 or DAC-50 is installed)



- High-sensitivity analog peak power meters



- Supplied Remote Commander RC-230
Allows volume adjustment, input source switching etc.



- | | | |
|--------------------------------|--|--|
| 1 Speaker output selector | 6 Mono / stereo selector button | 11 Balance control |
| 2 Bass control | 7 Loudness compensator on / off button | 12 Preamp / power amp separator switch |
| 3 Treble control | 8 DAC input selector button | 13 Recorder selector |
| 4 Tone control on / off button | 9 MC / MM selector button | |
| 5 Phase selector button | 10 Display mode selector button | |



Line input and output connectors

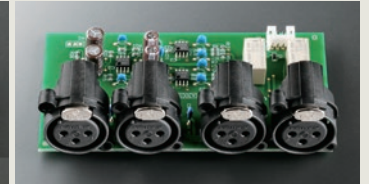

Balanced input connectors



Protection circuitry with MOS-FET switches



MOS-FET switches

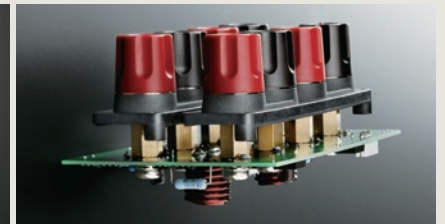

Speaker terminals with thick, short connecting shafts and protection circuitry



Bi-amping for further enhanced sound

In a bi-amped setup, the speaker units for the LOW frequency range and the HIGH frequency range are driven by separate amplifiers with equal gain, which enables playback with even higher sound quality.

*The speakers must have a built-in crossover network and separate inputs for the LOW and HIGH range.

*The example shows a setup with an additional power amplifier for the low frequency range.

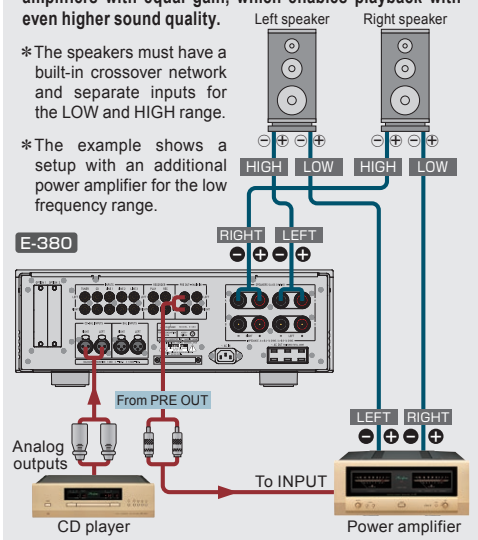

Option Boards



Photo shows an option board installation example.

Rear panel expansion slots allow use of three types of option boards (DAC-50, AD-50, LINE-10). Up to two boards can be inserted, according to requirements.

■ The following option boards can also be used:

Digital Input Board	DAC-10/DAC-20/ DAC-30/DAC-40
Analog Disc Input Board	AD-9/AD-10/ AD-20/AD-30
Line Input Board	LINE-9

Analog Disc Input Board AD-50

Features a high-performance phono equalizer for playback of analog records.

- Supports MC and MM cartridges
- Load impedance selector button (for MC only)
- Subsonic filter

Cartridge	MC	MM
Gain	66 dB	40 dB
Input Impedance	30 ohms 100 ohms 300 ohms	47 kilohms

AD-50

Digital Input Board DAC-50

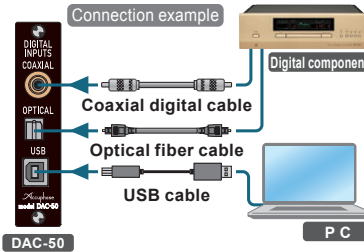

High-performance DAC with two AK4490EQ chips from Asahi Kasei Microdevices driven in parallel.

Input	Signal	Sampling frequencies	Number of bits
USB	DSD	2.8 MHz	1-bit
		5.6 MHz	
		11.2 MHz [ASIO only]	
OPTICAL	PCM	32 to 384 kHz	32-bit
		32 to 96 kHz	24-bit
COAXIAL	PCM	32 to 192 kHz	24-bit

DAC-50

Line Input Board LINE-10

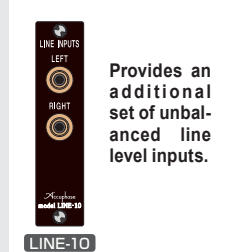

Provides an additional set of unbalanced line level inputs.

LINE-10

Front Panel

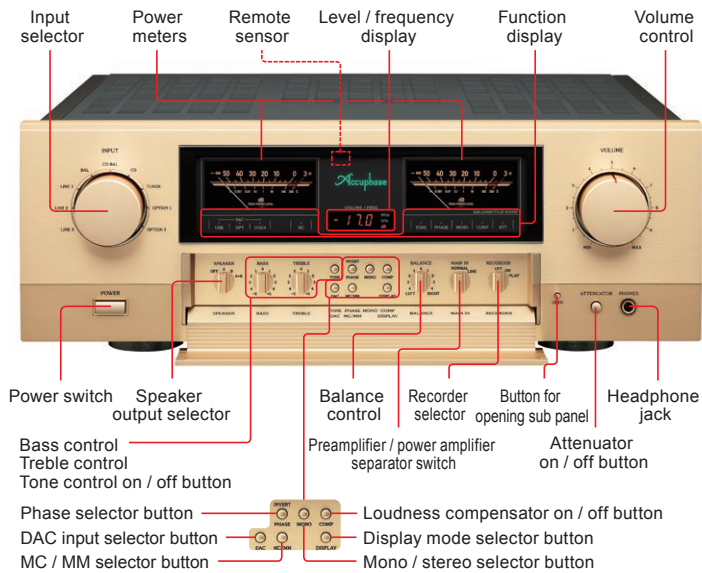

Rear Panel

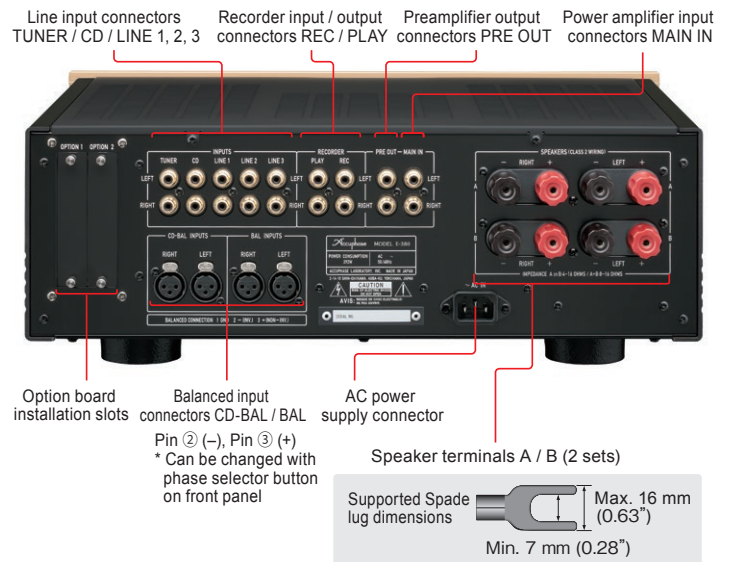

E-380 Guaranteed Specifications [Guaranteed specifications are measured according to EIA standard RS-490.]

Continuous Average Output Power (20 – 20,000 Hz)	(both channels driven)	8-ohm load	120 W	
		4-ohm load	180 W	
THD (20 – 20,000 Hz)	(both channels driven)	4 to 16 ohm load	0.05%	
Intermodulation Distortion	0.01%			
Frequency Response	HIGH LEVEL INPUT	*	20 – 20,000Hz (+0, -0.5 dB)	
	MAIN IN	*	20 – 20,000Hz (+0, -0.2 dB)	
		At 1 watt output:	3 – 150,000 Hz (+0, -3.0 dB)	
Damping Factor	500 (with 8-ohm load, 50 Hz)			
Input Sensitivity, Input Impedance	Input	Input sensitivity		
		For rated output	For 1 W output (EIA)	
	HIGH LEVEL INPUT	155 mV	14.2 mV	20 kilohms
	BALANCED INPUT	155 mV	14.2 mV	40 kilohms
MAIN IN	1.23 V	113 mV	20 kilohms	
Output Voltage	PRE OUTPUT	1.23 V*		
Output Impedance	PRE OUTPUT	50 ohms		
Gain	HIGH LEVEL INPUT → PRE OUTPUT		18 dB	
	MAIN IN → OUTPUT		28 dB	

*: At rated continuous average output

Remarks

- ★ This product is available in versions for 120/220/230 V AC. Make sure that the voltage shown on the rear panel matches the AC line voltage in your area.
- ★ The 230 V version has an Eco Mode that switches power off after 120 minutes of inactivity.
- ★ The shape of the plug of the supplied AC power cord depends on the voltage rating and destination country.

Supplied accessories
● AC power cord
● Remote Commander RC-230

• The specifications and appearance of this product are subject to change without notice.
http://www.accuphase.com



ACCUPHASE LABORATORY, INC.

K1905Y PRINTED IN JAPAN 850-2216-00 (B1)